

BRO 2422-\_\_\_\_-\_\_\_\_-\_\_\_\_

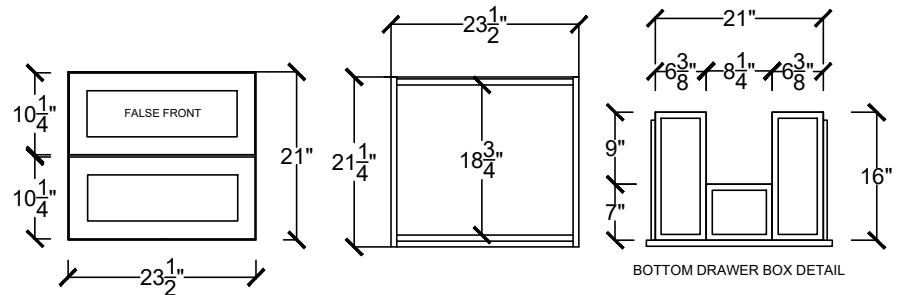

BRO 2422 1FF 1U-\_\_\_\_-\_\_\_\_-\_\_\_\_

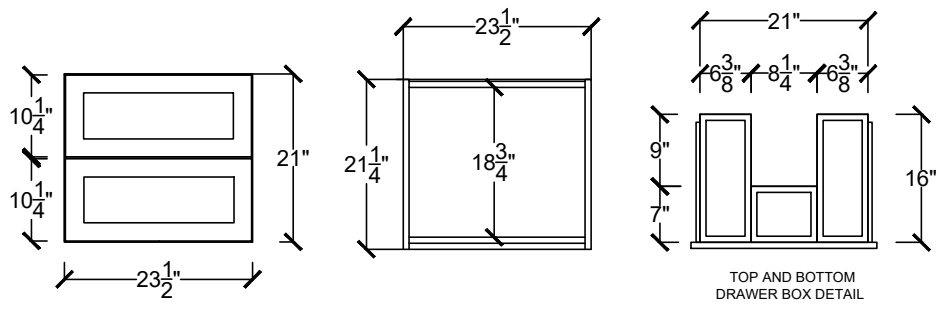

BRO 2422 2U-\_\_\_\_-\_\_\_\_-\_\_\_\_

**NOTE:  
VESSEL SINK  
STRONGLY  
RECOMMENDED**

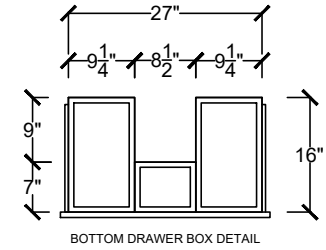
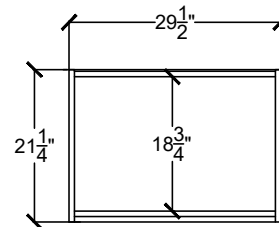
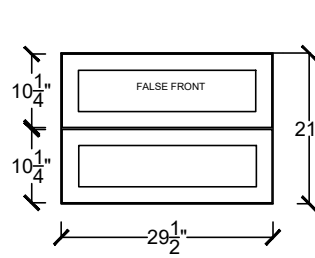
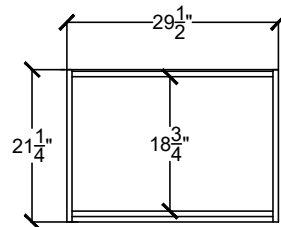
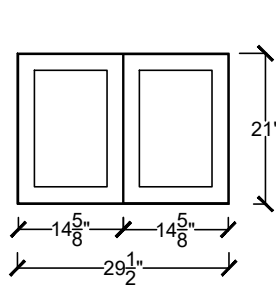

BRO 3022-\_\_\_\_-\_\_\_\_-\_\_\_\_

BRO 3022 1FF 1U-\_\_\_\_-\_\_\_\_-\_\_\_\_

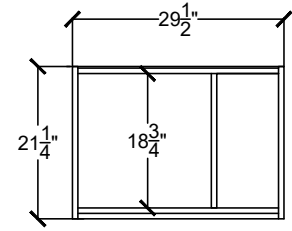
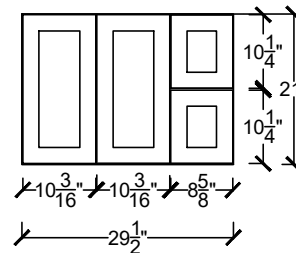
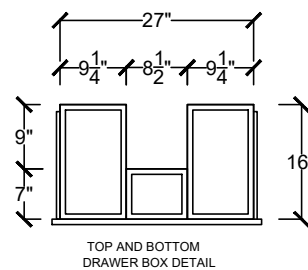
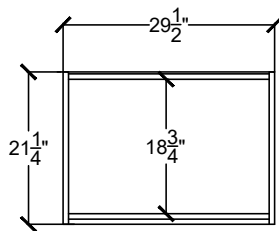
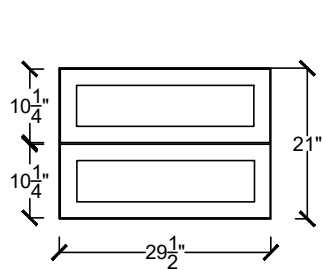

BRO 3022 2U-\_\_\_\_-\_\_\_\_-\_\_\_\_

BRO 3022 2DR OR 2DL -\_\_\_\_-\_\_\_\_-\_\_\_\_

NOTE:  
VESSEL SINK  
STRONGLY  
RECOMMENDED

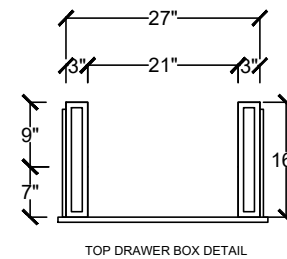
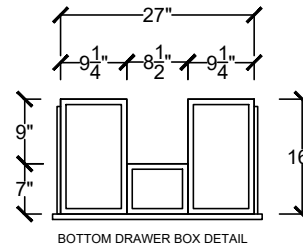
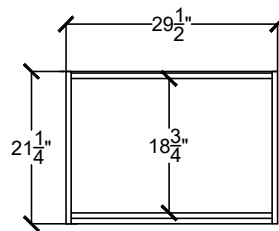
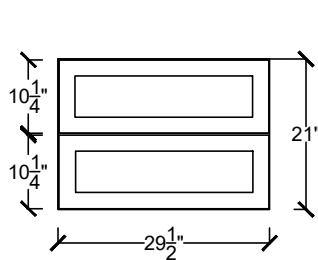

BRO 3022 2D-1U-\_\_\_\_-\_\_\_\_-\_\_\_\_

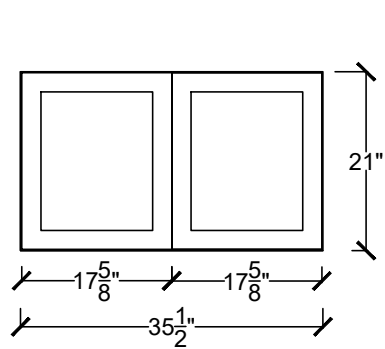

BRO 3622-\_\_\_\_-\_\_\_\_-\_\_\_\_

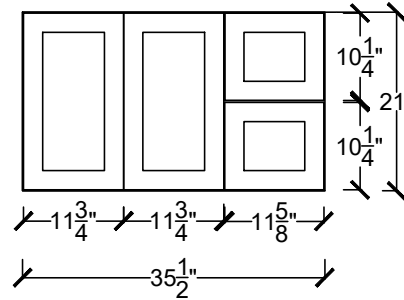
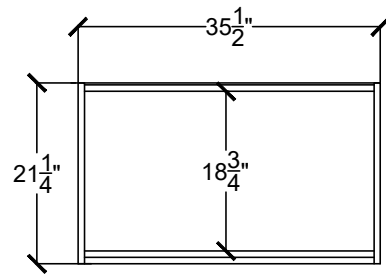

BRO 3622 2DR OR 2DL -\_\_\_\_-\_\_\_\_-\_\_\_\_

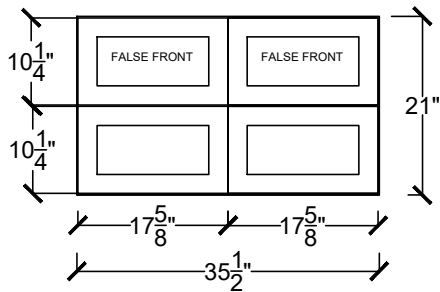
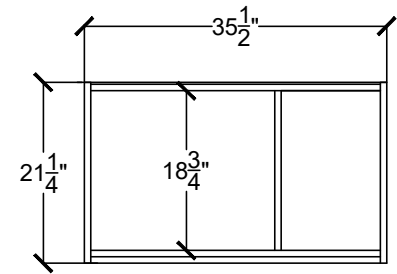

BRO 3622 2FF 2D-\_\_\_\_-\_\_\_\_-\_\_\_\_

